



SECTION 3

Manufactured by _____
 Model _____
 Overall door height _____

DEALER _____
 Address _____

CONTACT _____

Phone _____

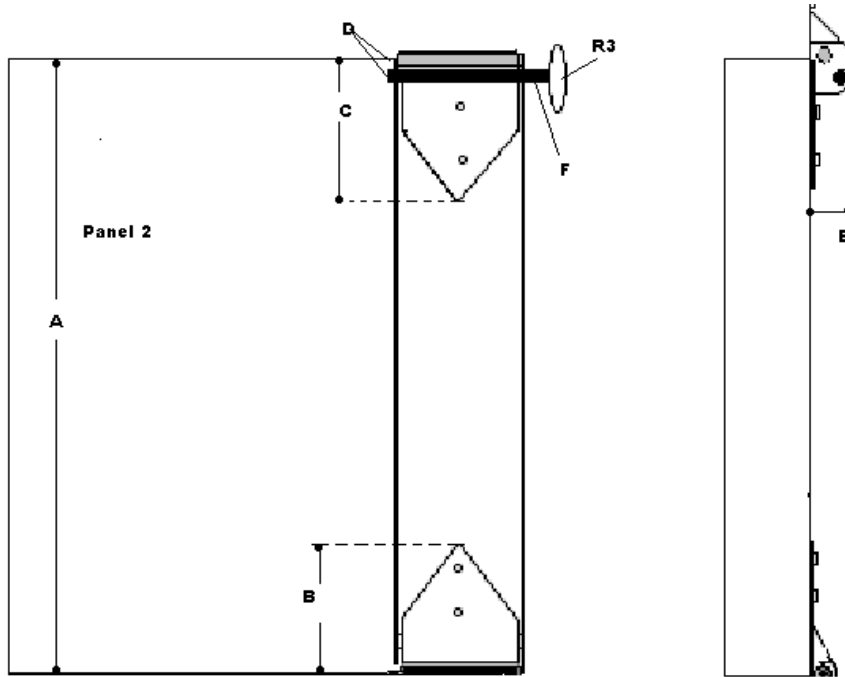

SECTION 3

- (A) Panel height in inches _____
- (B) Bottom of panel (3) to the top of hinge bracket _____
- (C) Top of panel (3) to the top of hinge bracket _____
- (D) Top of panel (3) to the center of AXLE _____
- (E) Distance from panel to OUTSIDE of axle (furthest point from panel) _____
- (F) Diameter of axle _____